

# Tapillo 2 in 1 Air and Water Tap User Manual

## Install Method

**1** Install air tap

- Insert the threaded end of the air tap into the mounting hole on the platform or basin, put in rubber gasket, Wave washer, Positioning gasket, Fasten screw nut, tighten the nut after adjusting the position.

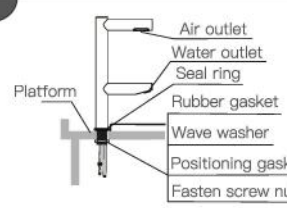

**2** Disassemble the cover

- First pull the HEPA rack out, use a Phillips screwdriver to loosen the screws that secure the cover, then turn the lower part of the cover outward, heard a "click", indicating that the upper buckle has been disengaged and remove the cover.

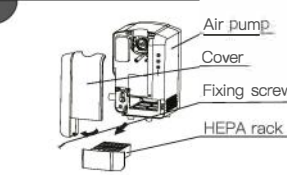

**3** Install the mounting plate

- The air pump can be installed on the wall or placed directly. If you choose to place directly it, skip to step 5.
- If the mounting surface is a woodbased panel, it can be directly fixed with self-tapping screw if not, please press the image on the right.
- According to the installation position, put the mounting plate with one hand gently holding in the place which the machine will be installed. Then use the other hand to draw the positions of mounting holes with pencil.
- In accordance with the drawn holes position, drill four holes 6 mm in diameter and press the expansion pipes into four holes.

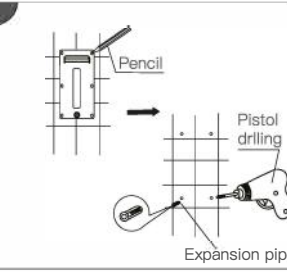

**4** Install air pump

- Hook the hook slot on the air pump into the hook on the mounting plate, press down it until the safety crew holes on machine and mounting plate are aligned, Screw in the safety screw and tighten.

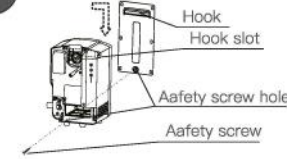

**5** Install Hose assembly

- Push the induction line and water pipe down into the hose assembly then screw the large nut on the top of the hose to the air tap, To prevent air leaks, the nut must be tightened. then, the limit ring on the induction line and water pipe are snapped into the limit slot on the corresponding hose connector, and it must be stuck in place if there is not carded in place, air leakage may occur.
- Adjust the relative position of the two mounting holes under the hose connector to the mounting holes on the air pump to align them, screw in the fixing screw to secure the hose assembly to the air pump, the screws need to be tightened to prevent air leaks.
- Connect the connection plug on the induction line to the connection socket on the air pump and secure it with the cable clamp.
- Apply lubricant to the solenoid valve outlet, then insert the water pipe into the water outlet and fasten it with the included hoop.
- Use a braided hose to connect the solenoid valve inlet to the water source.

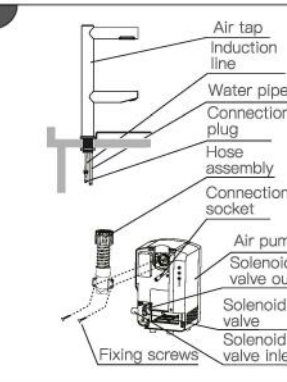

**6** Install cover and HEPA rack

- Insert the two slots on the top of the cover into the two buckles on the air pump, push the lower part inward, and fix it with the fixing screws.
- Push the HEPA rack into the air pump as shown.

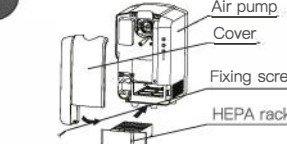

## Test Run

	Steps	Confirm information	Check & Notice
1	Shake the machine gently	The machine is installed firmly without shaking	If not installed correctly, the unit will shake and make noise during operation
2	Confirm the power and voltage	Please use the rated voltage	Incorrect voltage may burn out machines or cause accidents if the power use is incorrect
3	Switch on the power	Make sure power cord is correctly wired	Please check power flow when the indicator light is not bright
4	Slide hands under water outlet at correct distance to wash optimal	The water flows out when the hand is placed underneath	Confirm whether your hands are at the correct distance from the Inductor if it does not flow out
5	Slide hands under air outlet at correct distance to dry optimally	The airflow should blow out when the hand is placed underneath	Confirm whether your hands are at the correct distance from the Inductor if it does not blow out

## Function introduction

There are three touch buttons on the air pump, which are power switch, heating switch and air speed switch.

- Power button(Child lock):** The machine enters the standby state after power-on. In the standby state, it will enter to 'Child lock' mode if it doesn't operate within one minute. Meanwhile, the gear indicator lamp dimmed. Long press and hold for 3 seconds to unlock. When the 'Child lock' is unlocked, short press the power button to turn off the machine and then short press the power button again to enter standby.
- Speed button:** The factory default is one gear, which lights up one light. When pressed the button, it turns into two gears, which lights up two lights. And press it again to change to the third gear to light up three lights, and then press it again to change to the fourth gear (high speed) with four lights. Fully lit, press it again to turn into a gear, turn on a light, and so on.
- Heating button:** The default setting of heating mode is intelligent heating. It doesn't heating at room temperature above 25 degrees and the heating is automatically turned on when room temperature is below 25 degrees. After pressing the heating button in smart mode, the indicator of the gear changed from Blue to yellow, the heating mode changes from intelligent heating to forced heating. Otherwise, the indicator light changes from yellow to blue, and the heating mode changes from forced heating to intelligent heating.

## Daily Use and Maintenance

**External maintenance**

- Best cleaned with a soft dry cloth and neutral detergent. Do not use organic solvents, acid or alkaline toilet cleaner, cleaning brush, etc.
- Please turn off the power when removing dirt from the Sensing device.

⚠ Otherwise, it will destroy the machines surface finish and/or produce discoloration.

⚠ If using a chemical cloth, be sure to read the directions first.

**HEPA and filter cleaning**

- HEPA and filter are cleaned once every 2-3 month according to the usage. It can be washed directly with water, and it must be dried before use.

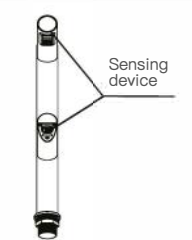

**Optimal Air Tap Method**

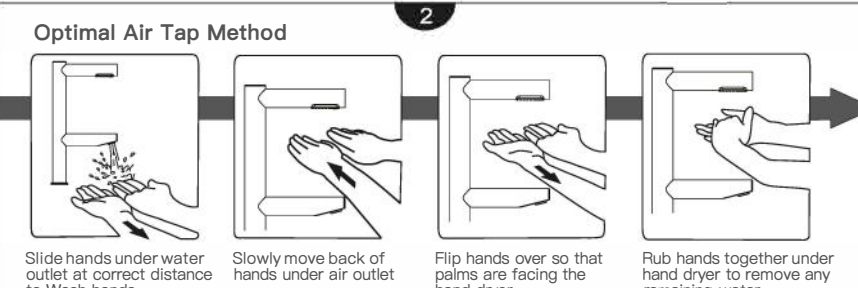



## Specifications

Rated Voltage	AC220-240V	Motor	Brush Motor
Phase	Single-phase	Sensing Distance	8-12cm
Input Power	1200-1400W	Waterproof	IP24
Air Speed	90m/s	Dimensions	315x216x191mm
Heating Power	650-750W	N.W	5.7kg

## WARNING

**Warning** If you don't use this unit properly or follow the safety guidelines carefully, it would lead to serious personal injury or property damage

**Prohibited**

- Do not let children hanging on the unit. Otherwise, this may be risk of falling.
- Do not open the front panel. Otherwise, it may cause electric shock risk.

**Do not spray water**

- Do not allow the unit to get wet, this can cause electric shock.

**Prohibit the use in bathrooms and showers**

- If water is allowed inside of the unit, this can cause electric shock and unit malfunction.

**Prohibit disassembling**

- Do not modify and disassemble the unit unnecessarily. Otherwise, this may cause a fire, electric shock, or personal injury.

- Rated power is required.
- If power tolerance is over +/-10%, there will be breakdown. If using incorrect power supply, fire, electric shock and unit malfunction will happen.
- Please use dedicated socket.
- If used in combination with other appliances, it may cause abnormal heat in the shunt outlet.
- Power must be turn off during maintenance to prevent the risk of electric shock. Air filter must be installed.
- Do not attempt to repair if you are not an authorized technician. See warranty for replacement information. Air filter must be installed.
- If the unit doesn't work or have abnormal conditions, please turn off power to prevent accidents; and close leakage circuit breaker and ask supplier to check and repair, or it may lead to fire because of electricity leakage and short circuit.
- The machine must be installed by a professional authorized personnel.

**Attention during installation:**

- Do not install when the machine is connected to power.
- This appliance is not intended for use by persons (including children) with reduced physical, sensory or mental capabilities, or lack of experience and knowledge, unless they have been given supervision or instruction concerning use of the appliance by a person responsible for their safety.
- Never use a unit if the cord is damaged in any way. Refer to warranty for replacement information.
- For additional protection, the installation of a residual current device (RCD) having a rated residual operating current not exceeding 30mA is advisable in the electrical circuit supplying the bathroom. Ask your installer for advice.

**Warning**

- Environmental protection  
Waste electrical products should not be disposed of with household waste. Please recycle where facilities exist. Check with your local authority or retailer for recycling advice.

## Feature

- Use filter and HEPA double filtration to remove 99.9% of bacteria.
- No touch hand drying ensures complete hygiene.
- No need paper towels. ease of maintenance.
- Save space, no need to set up a dedicated dry hand area.
- The air faucet is made of 304 stainless steel, solid and beautiful.
- The motor has four speed gears control functions, the speed gear has a memory function for the last working state.
- Auto-stop function, when the working time of the air faucet exceeds 45 seconds (the water faucet is 30 seconds), the machine will automatically stop working, when the hand reaches the sensing area again, the machine automatically resumes working.
- Priority principle: When you are using either one of the faucet and the air faucet, the other can't work.

## Name of Each Part

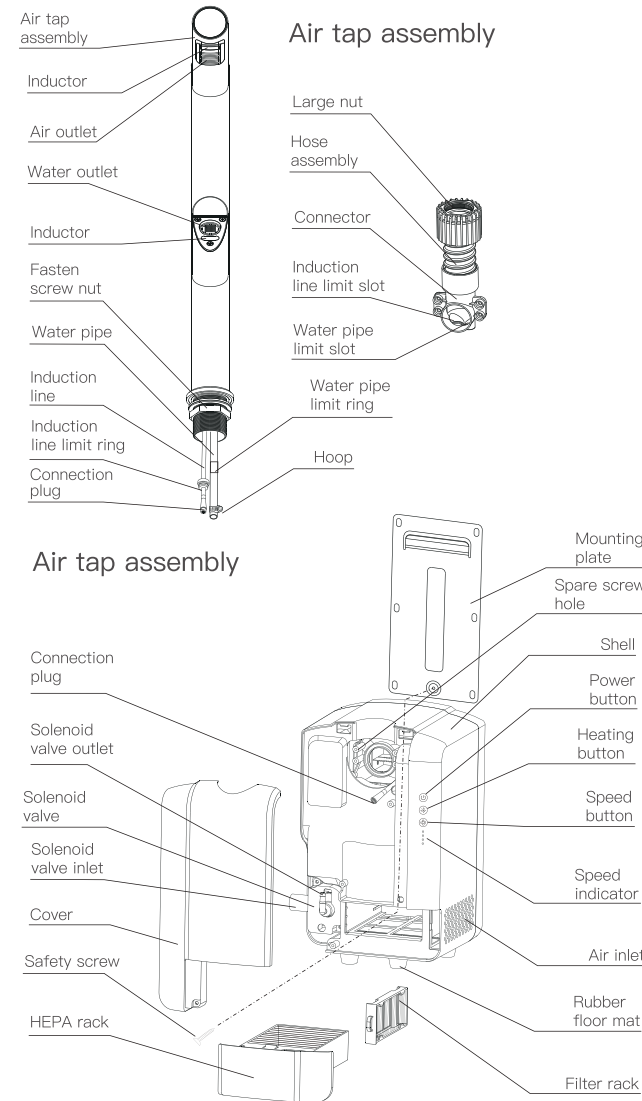

## Electrical Diagram

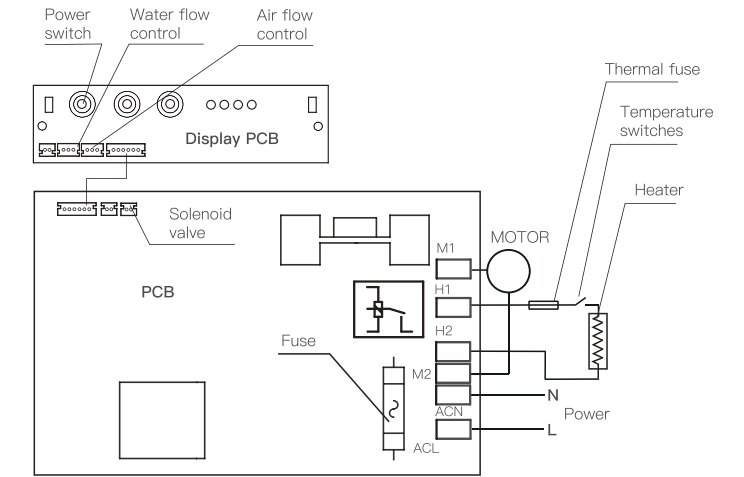

## Precautions before Installation

- Do not install in the following places (Otherwise may cause malfunction).
  - Place with temperature below  $-10^{\circ}\text{C}$  or over  $40^{\circ}\text{C}$
  - Place directly sprinkled by water
  - Place with direct sunlight, strong light
  - Place easy for condensation
  - Place filled with corrosive, oxidizing and reducing gas
  - Place with altitude over the range of 0 ~ 2000m

### Installation location

- The following picture shows the recommended location: If there are walls, partitions, obstacles, etc. next to the air inlets on both sides of the air pump, at least 150mm apart.
- The air pump can be installed on the wall or placed directly on the floor.
- If need to install on wall, please choose a flat wall to mounted air pump.
- If there is no hole to installed the air tap on the platform, need to drill a mounting hole in a suitable place with a 35mm diameter drill hole.
- In order to facilitate the tightening of the large nut, the peripheral distance of the center of the large nut should be more than 35mm.

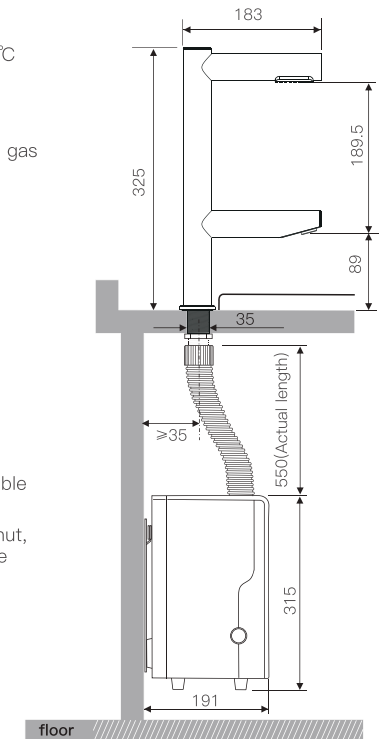

power cord should be 1.0mm<sup>2</sup>-1.5mm<sup>2</sup>